

4" x 8" x 16" Solid Block

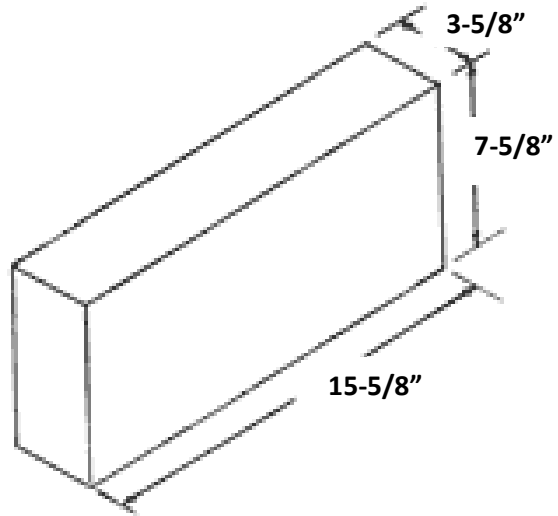

Certificate Of Compliance

Date:

Project:

Masonry Contractor:

Standard Normal Weight Concrete Masonry Units "Lot H"

This will certify that Barnes & Cone's Standard Normal Weight Concrete Masonry Units minimum properties will exceed the following standards and specifications:

Astm C 90-12 "Standard Specification For Loadbearing Concrete Masonry Units."

All aggregates used in the manufacture of these cmu will comply with ASTM C 33 – "Specification for Concrete Aggregates".

CMU Density Classification: Normal Weight

Average net area compressive strength will be a minimum of 1900 psi at 28 days

Portland Cement will comply with ASTM C150 "Specification for Portland Cement"

This certifies that Standard Normal Weight CMU manufactured by Barnes & Cone for this project will be "Lot H". ASTM defines "Lot" as "any number of concrete masonry units of any configuration or dimension manufactured by the producer using the same materials, concrete mix design, manufacturing process, and curing method."

BARNES & CONE

RICK ROACH